

GS514SZ Tech Sheet

Balboa Instruments System PN 54648-01

System Model # GS5-GS514SZ-RCA-3.0

Software Version # 43

EPN # 2808

Base PCBA - PN 54649-01

PCB GS500Z - PN 22015 Rev B

Base Panels

VL701S (Serial Standard) – PN 54561



System Revision History

System PN	EPN	Date	Requested By	Changes Made
54648-01	2808	08.28.2008	Balboa	Software update version 43.

Basic System Features and Functions

Power Requirements

Single Service [3 wires (line, neutral, ground)]

- 230VAC, 50Hz, 1~, 16A/32A, (Circuit Breaker rating = 20A/40A max.)

Dual Service [5 wires (line 1, neutral 1, line 2, neutral 2, ground)]

- 230VAC, 50Hz, 1~, 2x 16A, (Circuit Breaker rating = 20A max each service.)

3-Phase Service [5 wires (line 1, line 2, line 3, neutral, ground)] **Requires PCB Rev B.**

- 400VAC, 50Hz, 3N~, 16A, (Circuit Breaker rating = 20A max each phase line.)
- **IMPORTANT** - Service must include a neutral wire, with a line to neutral voltage of 230VAC.

System Outputs

Setup 1 (As Manufactured)

- 230V Pump 1, 2-Speed
- 230V Pump 2, 1-Speed
- 230V Pump 3, 1-Speed
- 230V Ozone
- 10V Spa Light
- 230V AV (Stereo)
- 3.0kW Heater *

Optional Devices

- 230V Circ Pump

* Heater wattage is rated at 240V.

Additional Options

- Full Feature Dolphin Remote and Spa-only Dolphin Remote
- IR Receiver Module
Connects to terminal J1 or J2
(Must be 8-pin connector)
- MoodEFX Lighting
Connects to Spa Light terminal J20
- FiberEFX Lighting
Connects to Spa Light terminal J20

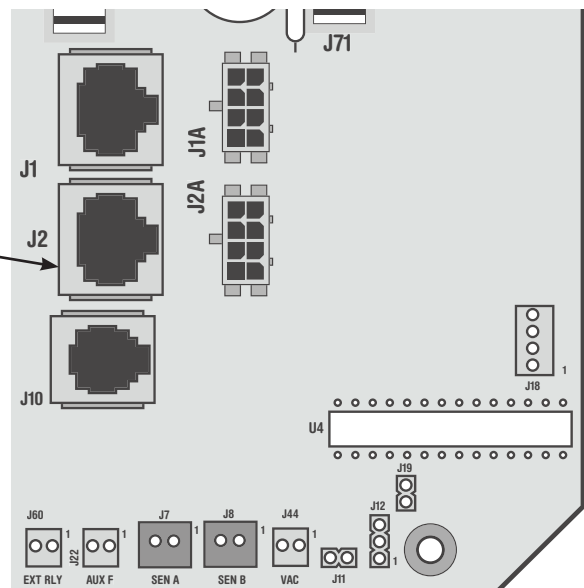

Basic System Features and Functions

Any time you change a DIP Switch, other than A1, you must reset Persistent Memory for your new DIP Switch Settings changes to take effect. If you do not reset Persistent Memory, your system may function improperly.

To reset Persistent Memory:

- Power down by disconnecting power source from spa.
- Put a jumper across J43, covering both pins. (See illustration below)
- Power up by connecting power source to spa.
- Wait until “P” is displayed on your panel.
- Power down again.
- Remove jumper from J43 (May also move to cover 1 pin only)
- Power up again.

About Persistent Memory and Time of Day Retention:

This system uses memory that doesn't require a battery to store a variety of settings. What we refer to as Persistent Memory stores the filter settings, the set temperature, and the heat mode.

Persistent Memory is not used for Time of Day. Only models with a Serial Deluxe panel installed (VS5xxDZ and GS5xxDZ) can display the time. However, during power loss to the spa, the system will lose the correct time, and reset to 12:00 PM when power is restored.

Power Up Display Sequence

Upon power up, you should see the following on the display:

- Three numbers in a row, which are the SSID (the System Software ID). The third display of these numbers is the Software Version, which should match the version of your system. For example, if these three numbers are 100 67 38, that is a VS511SZ at version 38.
- Displayed next is: “24” (indicating the system is configured for a heater between 3 and 6 kW) or “12” (indicating the system is configured for a heater effectively* between 1 and 3 kW). “24” should appear for all VS models running at 240VAC. “12” should appear for all VS models running at 120VAC, as well as all GS models. (*A heater which is rated at 4 kW at 240VAC will function as a 1 kW heater at 120VAC.)
- “P” will appear to signal the start of Priming Mode.

At this point, the power up sequence is complete. Refer to the Reference Card for the VS or GS System model of your spa for information about how the spa operates from this point on, including how to adjust the Time of Day if using a Serial Deluxe style panel.

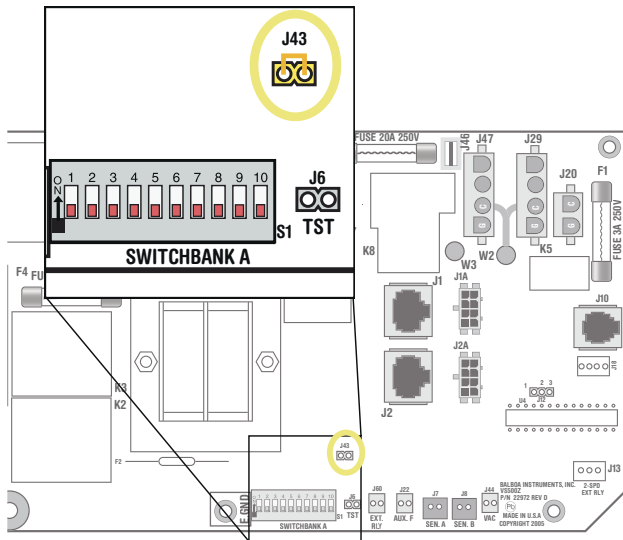

J43 on VS5xxZ and VS300 Series Main Board Shown.

J43 on GS5xxZ Series is located in approximately the same position.

Wiring Configuration and DIP Settings

Setup 1 (As Manufactured)

- 230V Pump 1, 2-Speed
- 230V Pump 2, 1-Speed
- 230V Pump 3, 1-Speed
- 10V Spa Light
- 230V Ozone
- 230V AW (Stereo)
- 3.0kW Heater
- VL701S Main Panel
- 230V Circ Pump (opt)

HiPot Testing Note:
 Disconnect slip terminal with green wires from J90 prior to performing HiPot test. Failure to disconnect may cause a false failure of the test.
 Reconnect terminal to J90 after successful completion of HiPot test.

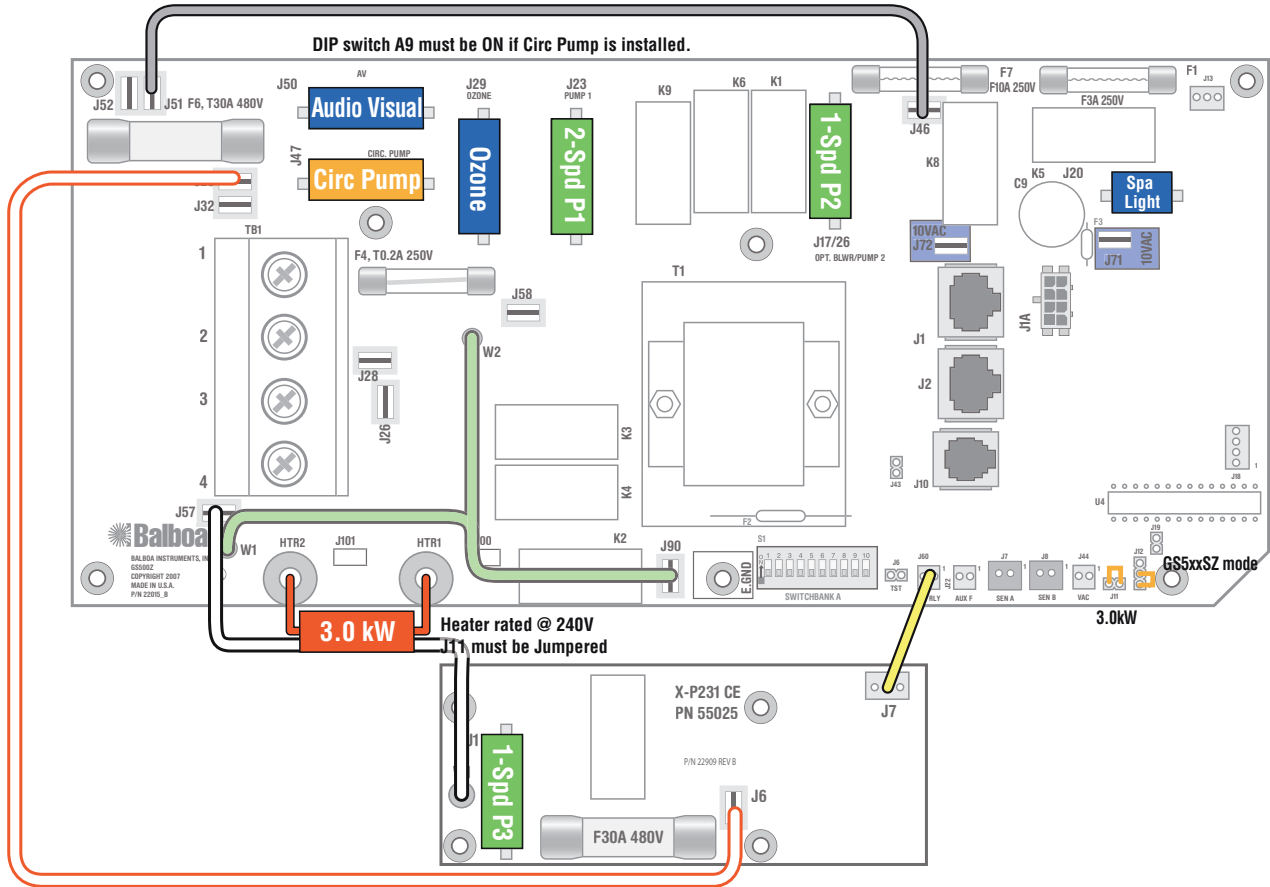

WARNING: Main Power to system should be turned OFF BEFORE adjusting DIP switches.
WARNING: Persistent Memory (J43) must be RESET to allow new DIP switch settings to take effect. (See Persistent Memory page)

SSID #
 100
 93
 43

Switchbank A

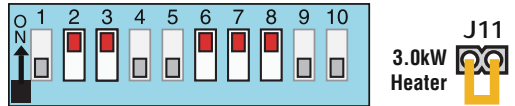

- | | |
|-------------------------|-----------------------------|
| A1, Test Mode OFF | A6, 50 Hz |
| A2, See Table 1 | A7, Exp Board Equip Enabled |
| A3, J17/26 Pump Enabled | A8, Degrees C |
| A4, Aux Freeze | A9, Non-Circ Mode |
| A5, 2-speed P1 | A10, See Table 1 |

GS503/504/514SZ Software

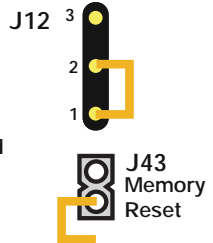

Wiring Color Key

- Neutral (Common) AC Connections
- Special AC Connections
- Line AC Connections
- 10 Volt Connections
- Relay Control Wires

Board Connector Key

- 1 Typically Line voltage
- 2 Typically Line voltage for 2-speed pumps
- 3 Neutral (Common)
- 4 Ground

Note flat sides in connector

- Panel Button Assignments**
- 1=Mode
 - 2=Temp Up
 - 3=Temp Down
 - 4=Light
 - 5=Pump 1
 - 6=Pump 2
 - 7=Exp Board

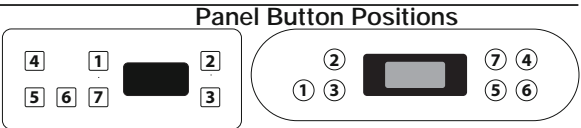

DIP Switches and Jumpers Definitions

SSID 100 93 43

Base Model GS503SZ-GS504SZ-GS514SZ

DIP Switch Key

- A1 Test Mode (normally OFF)
- A2+A10 Control amp draw requirements (See Table 1)
- A3 "ON" position: J17/26 Enabled for 1-speed Pump only.
"OFF" position: J17/26 Disabled.
- A4 Aux Freeze (must be OFF)
- A5+A9 Pump 1 speeds and Circ Modes:

A5	A9	Circ Mode	Pump 1 Speed
OFF	OFF	Non-circ	2-speed
ON	OFF	Circ "acts like Pump 1 low" (filters/polls/ect)	1-speed
OFF	ON	24 hours with 3°F shut-off	1-speed
ON	ON	24 hours with 3°F shut-off	2-speed

- A6 "ON" position: 50Hz operation
"OFF" position: 60Hz operation
- A7 "ON" position: Expander Board Enabled for Blower or 1-speed Pump.
"OFF" position: Expander Board Disabled
- A8 "ON" position: temperature is displayed in degrees Celsius
"OFF" position: temperature is displayed in degrees Fahrenheit

When using a Blower, use X-B CE expander board. When using a 1-speed Pump 3, use X-P CE or X-P231 CE, depending on amperage requirements.

* Panel with button layout  is not compatible.

		# of Hi-Speed Pumps/Blower Before Heat Disabled
A2	A10	
OFF	OFF	0
ON	OFF	1
OFF	ON	2
ON	ON	3

Jumper Key

- J11 If using 3kW or higher wattage heater, jumper can be set in either position, but may perform better on Pins 1 and 2. If using 2.5kW or lower wattage heater, jumper must be set on 1 Pin only.
- J12 **Factory set. DO NOT MOVE.**
Jumper must be on Pins 1 and 2 for GS51xZ/GS52xZ/GS5xxSZ/GS5xxDZ software.
Jumper must be on Pins 2 and 3 for GS50xZ software.
- J43 When jumper is placed on 2 pins during power-up, system will reset persistent memory. Leave on 1 pin only to enable persistent memory feature.

WARNING:

- Setting DIP switches incorrectly may cause abnormal system behavior and/or damage to system components.
- Refer to Switchbank illustration on Wiring Configuration page for correct settings for this system.
- Contact Balboa if you require additional configuration pages added to this tech sheet.

Panel Button Positions

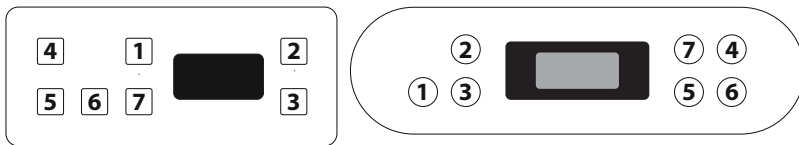

Panel Button Assignments

- 1=Mode
- 2=Temp Up
- 3=Temp Down
- 4=Light
- 5=Pump 1
- 6=Pump 2 (when A3 is ON)
- 7=Exp Board (when A7 is ON)

Aux Panel Information

Supports 2-button aux panel



Supports 4-button aux panel



Electrical Service Configuration Options

Systems with PCB Rev B Only

AS MANUFACTURED

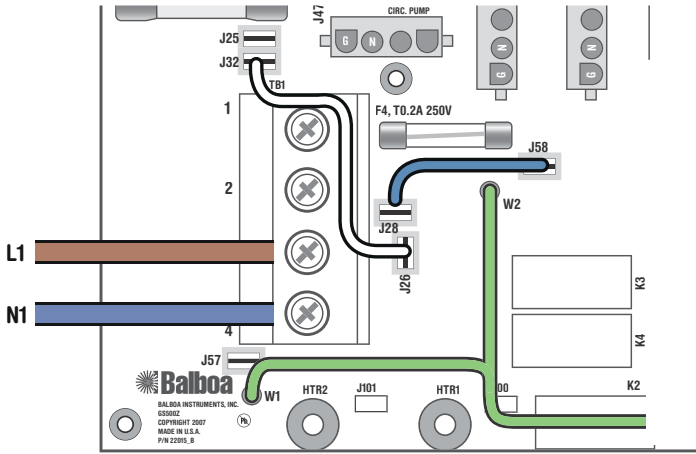

Single Service, TN and TT Electrical Systems (1 x 16 Amp or 1 x 32 Amp)

3 Wires (1 Line + 1 Neutral + 1 Protective Earth)

Protective Earth wire (Green/Yellow) must be connected to system ground terminal as marked.

This option is configured and shipped as the default.

All equipment (pumps, blower, and heater) runs on service line L1.

Systems using only 1 DIP switch (A10) for heat disable:

For 1 x 16 Amp Service:

DIP Switch A10 must be ON.

For 1 x 32 Amp Service:

Set DIP Switch A10 such that total system amperage draw never exceeds rated service input.

Systems using multiple DIP switches for heat disable:

Refer to system Hot Sheet DIP Switch Definition page and set the switches shown in Table 1 such that total system amperage draw never exceeds rated service input.

OPTIONAL

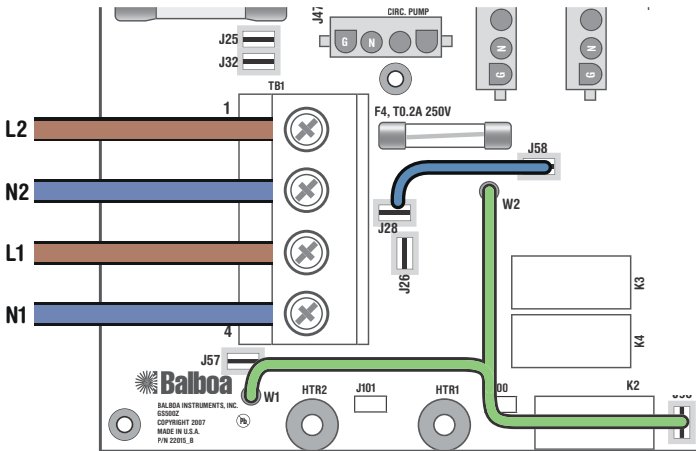

Dual Service, TN and TT Electrical Systems (2 x 16 Amp)

5 Wires (2 Lines + 2 Neutrals + 1 Protective Earth)

Protective Earth wire (Green/Yellow) must be connected to system ground terminal as marked.

The heater runs on service line L1, while all other equipment, such as pumps and blowers, run on service line L2.

Completely remove the white wire from J26 and J32.

Note: J32 and J25 are electrically identical. The white wire may be attached to either terminal before removal.

Systems using only 1 DIP switch (A10) for heat disable:

DIP Switch A10 must be OFF.

Systems using multiple DIP switches for heat disable:

Refer to system Hot Sheet DIP Switch Definition page and set both switches shown in Table 1 to ON positions.

Electrical Service Configuration Options

Systems with PCB Rev B Only

OPTIONAL

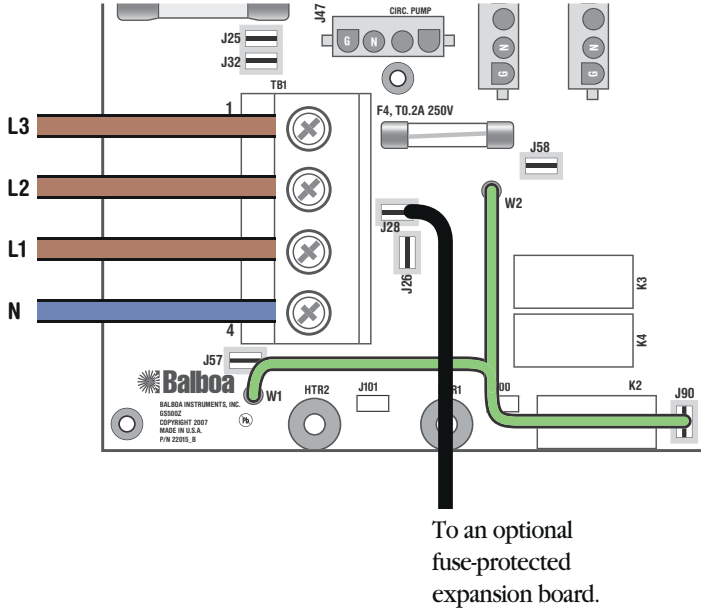

3-Phase Service, TN and TT Electrical Systems 5 Wires (3 Lines + 1 Neutral + 1 Protective Earth)

Protective Earth wire (Green/Yellow) must be connected to system ground terminal as marked.

IMPORTANT - Service **MUST** include a neutral wire, with a line to neutral voltage of 230VAC.

The heater runs on service line L1.

*All main-board equipment run on service line L3.
Additional equipment, such as expansion boards, run on service line L2.*

Completely remove the white wire from J26 and J32, or J25.
Completely remove the blue wire from J28 and J58.

If an expansion board is installed, black wire must connect to J28 (Line L2) only.

Systems using only 1 DIP switch (A10) for heat disable:
DIP Switch A10 must be OFF.

Systems using multiple DIP switches for heat disable:
Refer to system Hot Sheet DIP Switch Definition page and set both switches shown in Table 1 to ON positions.

NOTE:

- Not all GS5xxZ systems can support 3-Phase.
- 3-Phase requires System PCB Rev B.
- If using an expansion board, the board must have fuse-protection.

Electrical Service Configuration Options

Systems with PCB Rev B Only

AS MANUFACTURED

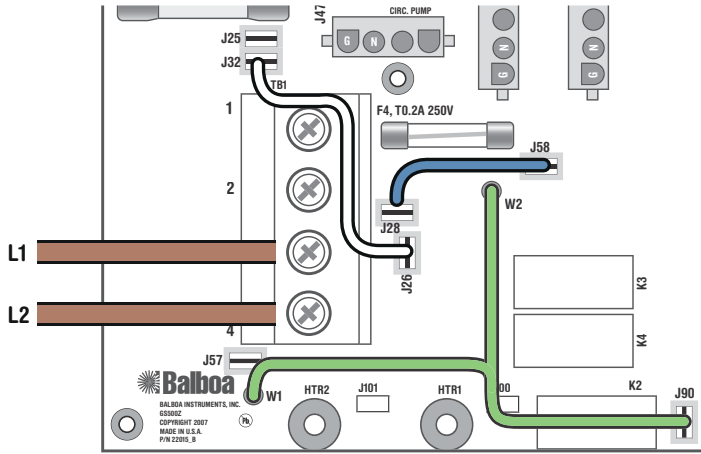

Single Service, IT Electrical System (No Neutral) Line - Line voltage is 230VAC (1 x 16 Amp or 1 x 32 Amp) 3 Wires (2 Lines + 1 Protective Earth)

Protective Earth wire (Green/Yellow) must be connected to system ground terminal as marked.

All equipment (pumps, blower, and heater) runs on service line L1 with L2 acting as the return.

Systems using only 1 DIP switch (A10) for heat disable:

For 1 x 16 Amp Service:

DIP Switch A10 must be ON.

For 1 x 32 Amp Service:

Set DIP Switch A10 such that total system amperage draw never exceeds rated service input.

Systems using multiple DIP switches for heat disable:

Refer to system Hot Sheet DIP Switch Definition page and set the switches shown in Table 1 such that total system amperage draw never exceeds rated service input.

OPTIONAL

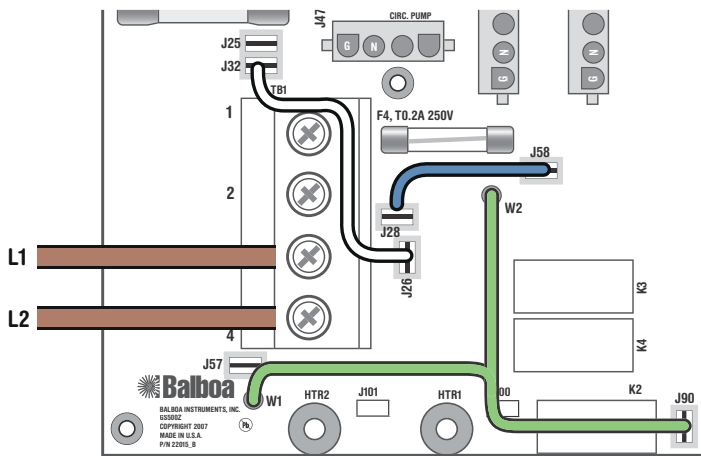

3-Phase Service, IT Electrical System (No Neutral) Line - Line voltage is 230VAC 4 Wires (3 Lines + 1 Protective Earth)

Protective Earth wire (Green/Yellow) must be connected to system ground terminal as marked.

All equipment (pumps, blower, and heater) runs on service line L1 with L2 acting as the return.

Systems using only 1 DIP switch (A10) for heat disable:

For 1 x 16 Amp Service:

DIP Switch A10 must be ON.

For 1 x 32 Amp Service:

Set DIP Switch A10 such that total system amperage draw never exceeds rated service input.

Systems using multiple DIP switches for heat disable:

Refer to system Hot Sheet DIP Switch Definition page and set the switches shown in Table 1 such that total system amperage draw never exceeds rated service input.



Line 3 - Cap (Insulate) end,
Do not connect.

NOTE:

- Not all GS5xxZ systems can support 3-Phase.
- 3-Phase requires System PCB Rev B.
- If using an expansion board, the board must have fuse-protection.

Ozone Connections

Note: A special tool is required to remove the pins from the connector body once they are snapped in place. Check with your Balboa Account Manager for information on purchasing a pin-removal tool.

Balboa Ozone connector configuration for 230VAC 50Hz:

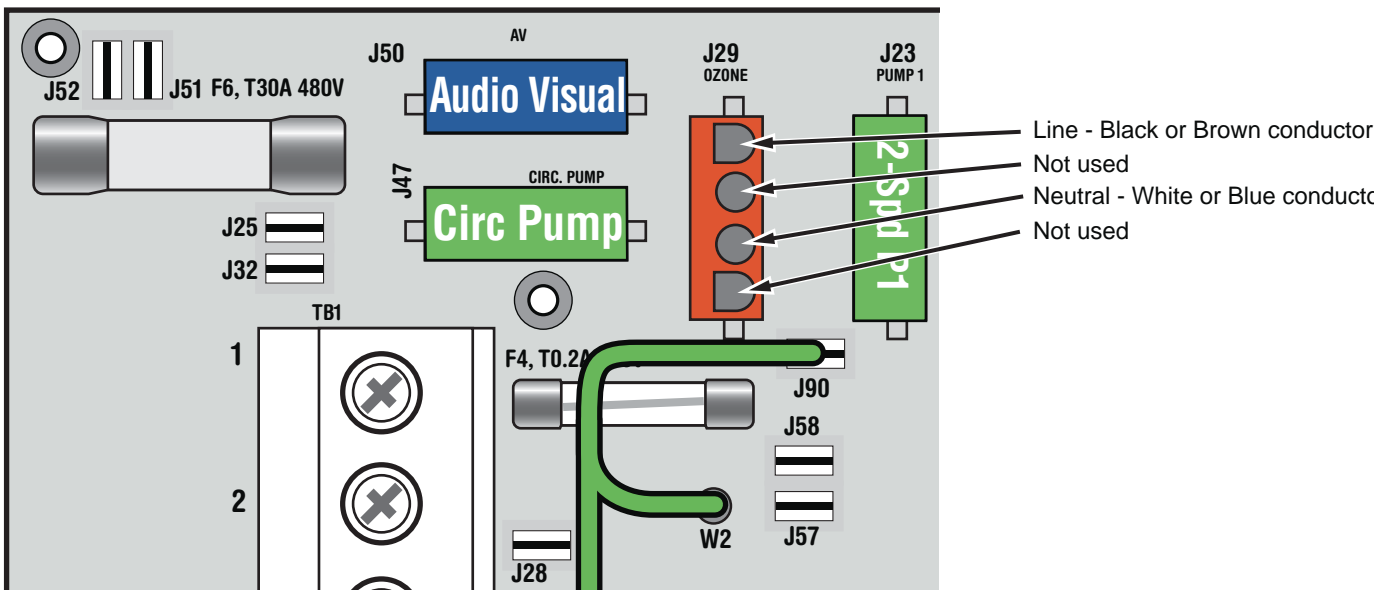
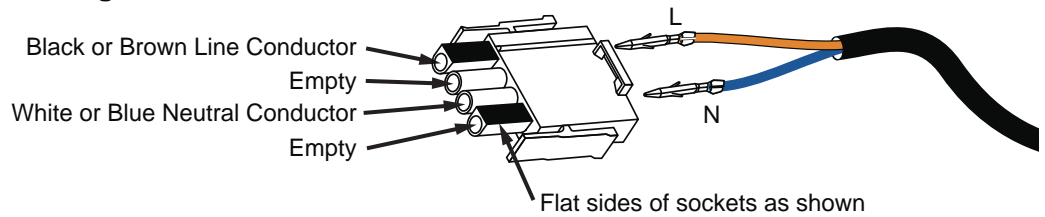

Serial Standard Panel Configurations

SETUP 1



VL701S (Serial Standard)

PN 54561 with Overlay PN 11609

- Connects to Main Board terminal J1 only*

* Panels with back-lighting (bulbs installed) should never be plugged into J2. Use J1 only. If the backlight bulbs are removed, then both J1 and J2 may be used.